

Vacuum Cleaner Operation Manual

 VCL20E-BK01A

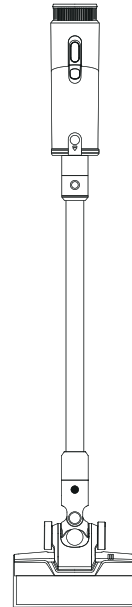

Manufacturer: UNITED GAIN LIMITED
Entrusting party: HANGZHOU GLOBAL JET ECOMMERCE CO., LTD
Address: I-2310, 501 2nd Avenue, QianTang New Area, Hangzhou, P.R. China
Telephone: 0571-88269187
Origin: Made in China

Please read this manual carefully before using the product and keep it properly for future reference.

This appliance is not intended for use by persons (including children) with reduced physical, sensory or mental capabilities, or lack of experience and knowledge, unless they have been given supervision or instruction concerning use of the appliance by a person responsible for their safety.

Children should be supervised to ensure that they do not play with the appliance.

If the supply cord is damaged, it must be replaced by the manufacturer, its service agent or similarly qualified persons in order to avoid a hazard.

The appliance was intended to household and indoor use.

Safety Notice for Using

Please carefully read and follow the "Safety Notice for Using" to ensure your safety and prevent property loss.

1. Please read this manual carefully before use.

2. Please check whether the voltage required by this product is consistent with the voltage in your home before use.

3. Do not use this product outside the specified scope.

4. Please use according to the design function of the vacuum cleaner.

5. It is not recommended to use this product by the following people (including children): those with physical and mental disabilities or those lacking relevant operating experience and knowledge, unless they are supervised and guided by the person responsible for their safety.

6. This product is a dry vacuum cleaner. Please do not use it to absorb detergent, kerosene, glass, needles, water wet dust, sewage, matches, etc.

7. Please keep the vacuum cleaner away from fire sources and other high temperature places.

8. Do not use the vacuum cleaner to absorb water and other liquids, and do not flush the whole vacuum cleaner with water.

9. When you need cleaning and maintenance or do not use the vacuum cleaner, please unplug the power plug and do not pull the power cord.

10. Please do not block the suction inlet when using the vacuum cleaner to avoid motor damage due to overload.

11. Please install the dust filter frame when using the vacuum cleaner to prevent dust from entering the motor.

12. Please do not use the vacuum cleaner to absorb cement, gypsum powder, wall powder and other small particles, so as to avoid clogging of the vacuum cleaner filter or filter screen, resulting in motor burning and other failures.

13. Please use a wet cloth stained with water or neutral detergent when cleaning the vacuum cleaner. Do not use gasoline, bananas, etc. to avoid cracking or fading of the shell.

14. Please read the instruction manual and diagram carefully before using this product.

15. Please do not let children play with this product.

16. When the power cord is damaged, it must be replaced by the manufacturer, its maintenance department or similar professionals to avoid danger.

17. Do not use high-power electrical appliances on the same circuit to prevent danger caused by overload of the circuit.

18. Do not use the product in case of any damage.

19. Please keep this manual properly.

Technical parameters

Model	Rated voltage	Rated power	Rated capacity
VCL20E-BK01A	22.2V 	200W	0.4L

Product parts

- Ergonomic handle
- Exit filter cover
- Dust can release button
- Dust can
- Box cover release button
- Metal tube release button
- Metal tube
- Electric floor brush release button
- Brush with multiple surfaces
- On/off switch
- Removable battery pack
- Indicator light
- Adjustable power level (2 levels)
- Adapter
- Flat nozzle brush
- 2 in 1 brush head
- Wall mount

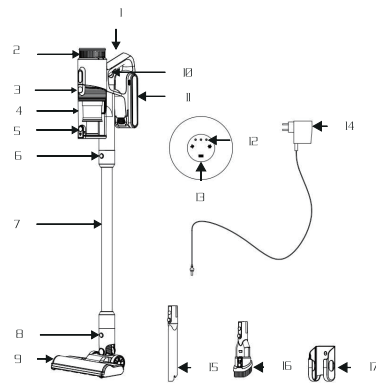

Specifications and components of this product are subject to change without notice.

Installation instructions

*Note: Do not plug in power during installation

1. Metal shell electron tube

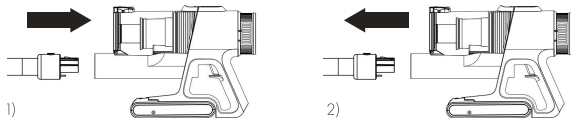

- 1) Insert the metal tube onto the host until you hear a click.
- 2) Press the metal tube release button, then remove the metal tube.

2. Floor brush installation

- 1) Insert the electric brush into the end of the tube until you hear a click.
- 2) Press the electric floor brush release button and remove the electric floor brush.

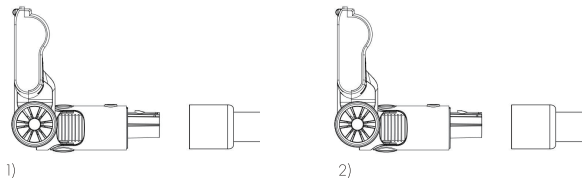

3. Battery installation

- 1) Install the battery into the bottom of the host until it clicks.
- 2) Press the battery release button and pull it out.

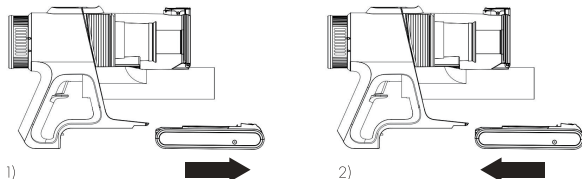

03  Qaabor

Cleaning and maintenance

Note: Please pull out the power plug before cleaning and maintenance
Use and maintenance:

Clean the filter screen assembly (please unplug the power supply before cleaning)
Please clean the filter screen immediately when the suction is weakened due to dust accumulation on the dust collector and filter screen assembly.

Cleaning of dust container and filter

1. Press the trash can release button, open the dust can lid, and empty the trash.
2. Press and hold the dust can release button, and then release the dust cup from the host.

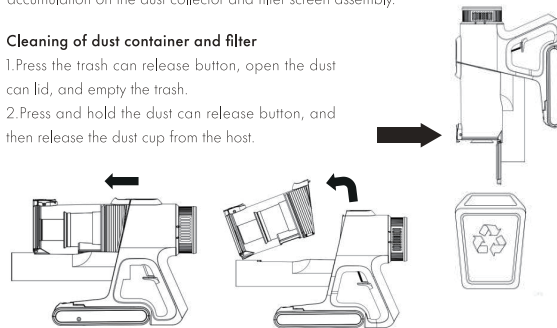

3. Hold the dust can, remove the inlet HEPA filter, and then lift out the filter cover. Turn counterclockwise and pull out the internal separator.

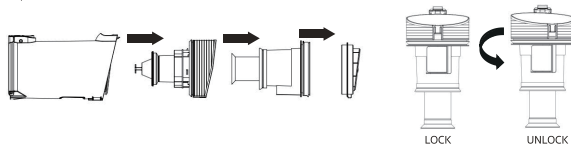

4. Clean all parts under running cold water.
5. Dry the filter completely before reassembly.

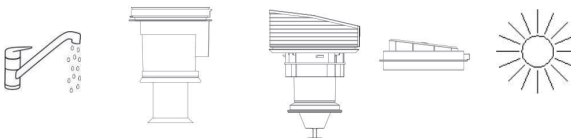

 Qaabor 04

Cleaning of floor brush

1) Remove the clips and the roller brush.

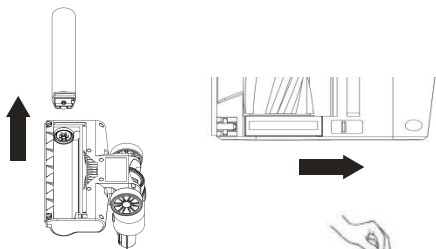

2) Remove hairs and debris from around the brush roller with your fingers or a knife.

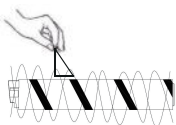

3) Clean the brush roller with tap water.



4) Dry the brush roller completely before assembly.



5) Put the roller brush back in place and reinstall the clip.

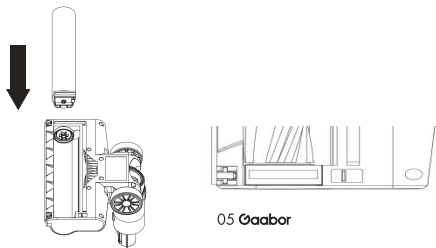

FAQ

Failure	Cause	Solution
The vacuum cleaner does not work	1.The vacuum cleaner may not have power; 2.The power socket has no power; 3.The power switch button of the vacuum cleaner is not pressed;	1.Charge the machine; 2.Check the circuit of the distribution box; 3.Press the power switch button;
Reduced suction	1.The plastic pipe is blocked; 2.Too much garbage in the dust cup; 3.Too much dust on the filter;	1.Remove the blockage 2.Clean up the garbage 3.Clean the filter frequently
Abnormal noise during motor operation	Check whether the plastic pipe and floor brush are blocked	Stop using immediately and remove the obstruction; Please contact our after-sales service department if there is still any abnormality
The machine stops working suddenly	The battery needs to be charged	Connect the charger to charge in time

Packing list

Name	Host	Connection tube	Floor brush	Adapter	Manual
Qty.	1	2	1	1	1

Name	Two-in-one brush	Flat suction	Wall mount	Battery pack
Qty.	1	1	1	1